



[www.klauke.com.cn](http://www.klauke.com.cn)

# ESG 25CFM



序列号

HE.16842\_G © 05/2016 R&D-2



EMERSON PROFESSIONAL TOOLS

地址：上海松江工业区江田东路 89 号

电话：400-820-5695

[www.klauke.com.cn](http://www.klauke.com.cn)

# Klauke®

Wir freuen uns, dass Sie sich für ein Klauke Werkzeug entschieden haben und wünschen Ihnen viel Freude damit.



Sie haben ein Qualitätsprodukt „Made in Germany“ erworben und erhalten 2 Jahre Garantie. Diese beginnt mit dem Kaufbelegdatum.

Um lange Freude und eine einwandfreie Funktion des Werkzeuges sicherzustellen, muss das Gerät spätestens beim Erreichen von 10.000 Arbeitsvorgängen oder nach 3 Jahren durch ein Autorisiertes Service Center (ASC) gewartet werden. Wird das Wartungsintervall von 10.000 Arbeitsvorgängen nicht eingehalten, erlischt der Garantieanspruch.

Im Rahmen dieser Wartung werden verschlissene Teile ersetzt und sicherheitsrelevante Teile geprüft und ggf. vorbeugend ersetzt.

Darüber hinaus empfehlen wir das Gerät jährlich zur Überprüfung an das zuständige ASC einzusenden.

Für Fragen rund um unseren Werkzeugservice oder eine Frage zu einem bestimmten Anwendungsfall stehen wir Ihnen persönlich unter der kostenlosen 0800-4685528 zur Verfügung.



Ihr Klauke Team

非常感谢您选择Klauke工具，祝您使用愉快。



您购买的是“德国制造”的优质产品，享受2年质保，保修期从收货之日起生效。

为了确保产品持久耐用，产品必须在10,000次操作或3年后由厂家进行维修。如果维修间隔超过10,000次，则保修要求无效。

该服务包括预测性维护、更换磨损的部件和检查/更换与安全有关的部件。

我们建议每年通过厂家对工具进行检查。

如对我们的工具服务或具体应用有任何疑问，请访问<http://www.klauke.com.cn/>。



扫码获取更多  
产品信息



# ESG 25CFM

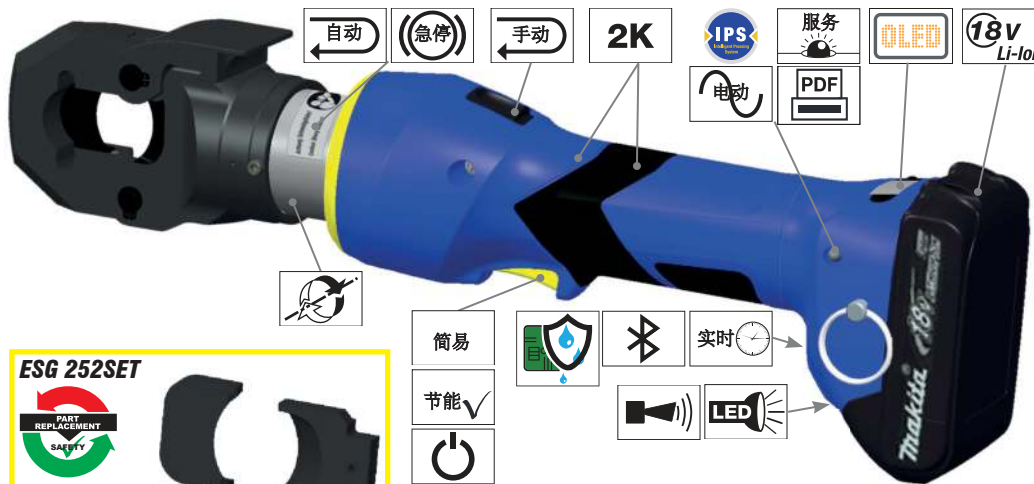

可选:  
 BL1850(B) (RAL4)  
 BL1840(B) (RAL40)  
 BL1830(B) (RAL2)



**ESG 252SET**

预期用途/  
可预期用途  
见图 IV  
替换  
见图 IX - XII

**ESG 252FSSET**

预期用途/  
可预期用途  
见图 V  
替换  
见图 IX - XII

2 years Warranty  
 ACHTUNG! Garantie Siegel  
 Be Beschädigung Garantie verliert  
 ATTENTION! Warranty seal  
 If broken loses Warranty

日期代码表

年	代码	月	代码	月	代码
2018	M	1月	N	7月	V
2019	N	2月	P	8月	W
2020	P	3月	Q	9月	X
2021	Q	4月	R	10月	Y
2022	R	5月	S	11月	Z
2023	S	6月	T	12月	1

仅适用于美国和加拿大

FCO编号: RFRMS42 · IC: 4957A-MS42  
 型号: CFM  
 本设备符合 FCC 规则第 15 部分和加拿大工业部可能允许的 BSS 标准。本设备运行须遵守以下两条规定: (1) 本设备不得造成有害干扰; 以及 (2) 本设备必须接受任何接收到的干扰, 包括可能影响操作性能的干扰。

HB.18955\_D

批号# 例 304711  
 日期代码 例 P = 2020; R = 4月  
 编号# 例 "142" = 第142号工具

304711  
 PR  
 142

**Klauke**  
 Auf dem Knapp 46  
 D-42855  
 Remscheid

工作 服务 不能做 DON'T DO 通用安全规则



ESG 25CFM

Klauke®

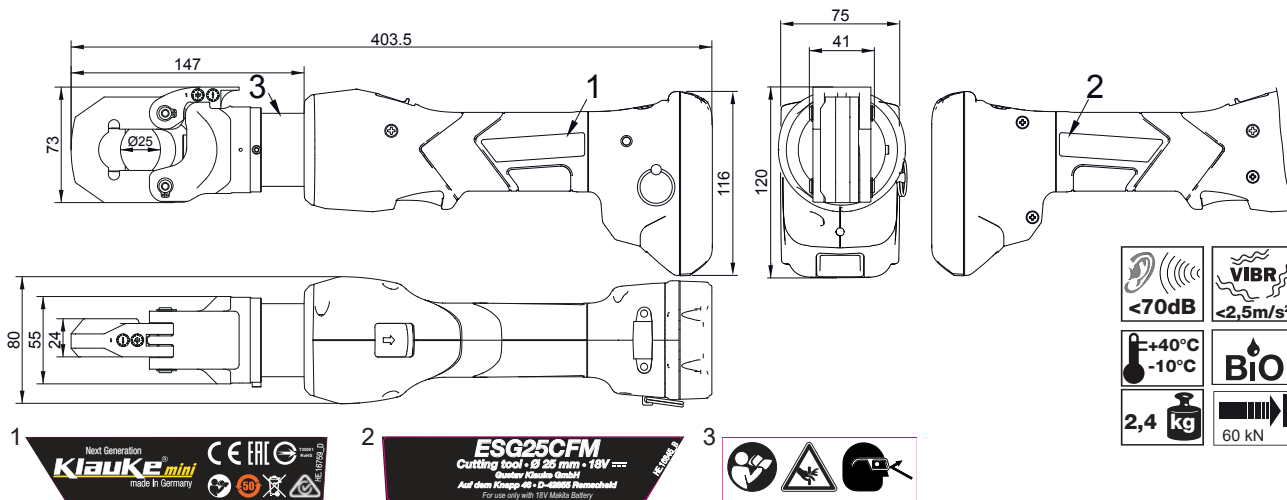

**警告**

阅读所有该电动工具提供的安全警示，指示，插图说明和规格说明书。  
不遵守以下指示可能导致电击，火灾或者严重的受伤。  
保存所有的警告信息和指示说明用于将来的参考。

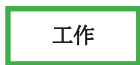









IEC  
60228

CL1&2





Bestimmungsgemäße Verwendung  
可用于

 Eindrähtiger Rundleiter 电缆 CL1 - re	 Mehrdrähtiger Rundleiter 电缆 CL2 - rm	 Verdichtet Mehrdrähtig 电缆 CL2 - mV 压实	
 Freileitung (Aldrey) 导线 CL2 - rm	 ACSR	 Armierter Leiter 加强型导线	



Vorhersehbare Fehlanwendung  
不可用于

 Feindrähtig 电缆 CL5 - F	 Feinstdrähtig 电缆 CL6 - F		



工作



服务



不能做



通用安全规则





IEC 60228

CL1&2

Ø25mm

**Bestimmungsgemäße Verwendung**  
可用于

Feindrähtig 电缆 CL5 - F	Feindrähtig Stahlseile 钢电缆	Mehrdrähtiger Rundleiter 电缆 CL2 - rm	Verdichtet Mehrdrähtig 电缆 CL2 - rmV 压实



**Vorhersehbare Fehlanwendung**  
不可用于

Feindrähtig 电缆 CL6 - F	Eindrähtiger Rundleiter 电缆 CL1 - re		
Freileitung (Aldrey) 导线 CL2 - rm	ACSR	Armierter Leiter 加强型导线	

工作



服务



不能做



通用安全规则





ESG 25CFM

Klauke

⚠️  $\angle > 350^\circ$  STOP

**Klauke ASC**  
Authorised Service Center

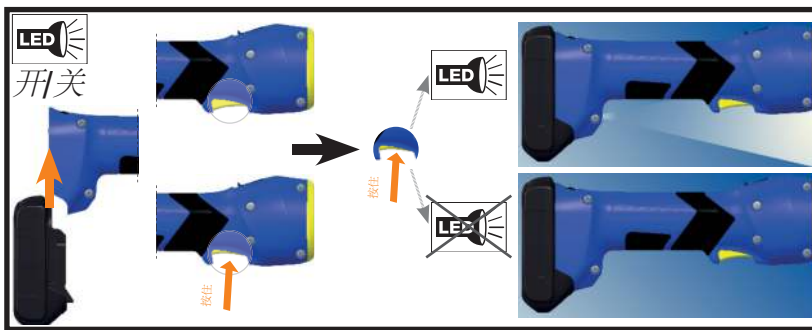

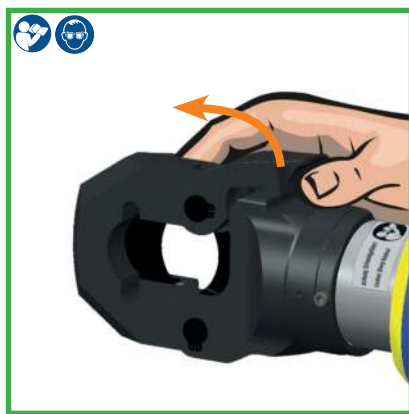
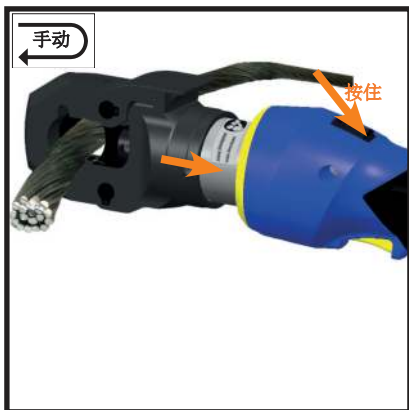















1			
2			
		ERROR CODE: ****	错误代码 *1
3a		BT P 3 bar P 3 bar	*2 蓝牙 (如有连接) 电量水平 实时压力 最大压力
3b		bar / psi	转换: bar / psi
3c		bar / psi	
3b		kN / lbf	转换: kN / lbf
3d		BT F 74 lbf F 369 lbf	
4a		USER 3: RD3 Doppelklick	双击
4b		USER SELECT: RD3 Einfachklick	单击 进入菜单
4c		USER SELECT: RD3 Doppelklick	双击 选择
4d		USER SELECT: RD3 Doppelklick	双击 确认
5		NEXT SERVICE: 9826 0Ps	剩余工作次数 (直至下一次保养)
6		TOTAL: t = 0.07 h Q = 21.12 Ah n = 174	自生产起: 运行时间 电量 #工作次数
7		← 返回 →	

- \*1 错误代码:
- 1过流熔断
  - 2过流比较器
  - 3电路板过热
  - 4过热电池
  - 5电量耗尽, 操作停止
  - 6压接电机运行故障
  - 7压接电机故障, 无法运行
  - 8电量低
  - 9电量耗尽
  - 10RTC电量低
  - 11工具失效
  - 12需要保养
  - 13RTC未找到
  - 14BT单元未找到
  - 16压力感应器未找到
  - 17超过最大压力
  - 18电池温度太低

\*2 (2Hz)





### Klauke i-press® Software

▶ [www.klauke.com/connectivity](http://www.klauke.com/connectivity)

### Klauke i-press® App



#### 注意事项:

未经Klauke明确批准而对本设备进行的更改或修改，可能会使操作本设备的FCC授权失效。





ESG 25CFM

Klauke®

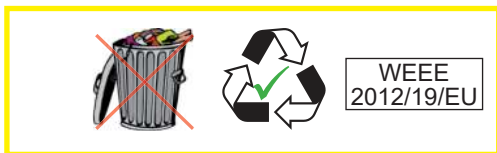





			Wann/时间/Quand/Quando/ cuándo/Когда/Когда/это происходит/Kiedy/quando	Warum/原因/Pourquoi/Porquê/ ¿por qué?/Warom/Причина/ Dlaczego/Perch
 20 秒			nach Arbeitsvorgang 压接周期完成后 après opération de travail Después del proceso de trabajo após o processo de trabalho na bedrijfsscyclus после цикла опрессовки po zakończeniu pracy dopo il processo di lavoro	
 20 秒/2Hz			nach Arbeitsvorgang 压接周期完成后 après opération de travail Después del proceso de trabajo após o processo de trabalho na bedrijfsscyclus после цикла опрессовки po zakończeniu pracy dopo il processo di lavoro	
 20 sec/5Hz			während der Übertemperatur 超过温度限制时 pendant surchauffé en caso de temperatura excesiva durante a temperatura excessiva tijdens te hoge temperatuur при высокой температуре внутри корпуса przy przegrzaniu superando il limite di temperatura	Werkzeug zu heiß 工具过热 outil surchauffé Herramienta demasiado caliente gereedschap te heet Перегрев инструмента urządzenie za gorące Utensile troppo caldo 

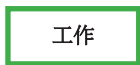

# Handgeführtes batteriebetriebenes Elektrowerkzeug Typ ESG 25CFM

**Klauke**

**(D)** CE-17 - Konformitätserklärung. Wir erklären in alleiniger Verantwortlichkeit, daß dieses Produkt mit den folgenden Normen oder normativen Dokumenten übereinstimmt: EN 62841-1, EN ISO 12100, EN ISO 13857, EN 349, EN 28662-1, EN 61000-6-3, EN 61000-6-2, EN 1037 gemäß den Bestimmungen der Richtlinien 2006/42/EG, 2014/30/EU, 2011/65/EU

**(GB)** CE-17 - 合格声明: 我们声明独自承担责任: 本产品符合以下标准或规范性文件:

EN 62841-1, EN ISO 12100, EN ISO 13857, EN 349, EN 28662-1, EN 61000-6-3, EN 61000-6-2, EN 60529, EN 1037, 符合2006/42/EG、2014/30/EG、2011/65/EU的规章制度。

**(F)** CE-17 - Déclaration de conformité. Nous déclarons sous notre seule responsabilité que ce produit est en conformité avec les normes ou documents normatifs suivants: EN 62841-1, EN ISO 12100, EN ISO 13857, EN 349, EN 28662-1, EN 61000-6-3, EN 61000-6-2, EN 1037 conformément aux réglementations des directives 2006/42/EG, 2014/30/EU, 2011/65/EU

**(E)** CE-17 - Declaración de conformidad. Declaramos bajo nuestra sola responsabilidad que este producto está en conformidad con las normas o documentos normativos siguientes: EN 62841-1, EN ISO 12100, EN ISO 13857, EN 349, EN 28662-1, EN 61000-6-3, EN 61000-6-2, EN 1037 de acuerdo con las regulaciones de las directivas 2006/42/EG, 2014/30/EU, 2011/65/EU

**(I)** CE-17 - Dichiarazione di conformità. Dichiariamo sotto la nostra esclusiva responsabilità che questo prodotto è conforme alle seguenti norme e documenti normativi: EN 62841-1, EN ISO 12100, EN ISO 13857, EN 349, EN 28662-1, EN 61000-6-3, EN 61000-6-2, EN 1037 conformemente alle disposizioni delle direttive 2006/42/EG, 2014/30/EU, 2011/65/EU

**(P)** CE-17 - Declaração de conformidade. Declaramos sob nossa exclusiva responsabilidade que este produto cumpre as seguintes normas ou documentos normativos: EN 62841-1, EN ISO 12100, EN ISO 13857, EN 349, EN 28662-1, EN 61000-6-3, EN 61000-6-2, EN 1037 conforme as disposições das directivas 2006/42/EG, 2014/30/EU, 2011/65/EU

**(NL)** CE-17 - Konformiteitsverklaring. Wij verklaren er wij stellen ons er alleen voor verantwoordelijk dat dit product voldoet aan de volgende normen of normatieve documenten: EN 62841-1, EN ISO 12100, EN ISO 13857, EN 349, EN 28662-1, EN 61000-6-3, EN 61000-6-2, EN 1037 overeenkomstig de bepalingen van de richtlijnen 2006/42/EG, 2014/30/EU, 2011/65/EU

**(GR)** CE-17 - ο στ ιτο ερωσληθ σηκλιουστ ηψηλανα εΜ ΣΗΣΩΦΡΟΜΜΥΣ ΗΣΩΛΗΔ πορον προιον συμφωνει με τα παρακατω ποστυπα και με τα ηροτυπα ηου αναφεροται στα σηκπο εγγραφα EN 62841-1, EN ISO 12100, EN ISO 13857, EN 349, EN 28662-1, EN 61000-6-3, EN 61000-6-2, EN 1037 συμφωνα με τοχ κοινοισμους 2006/42/EG, 2014/30/EU, 2011/65/EU

**(S)** CE-17 - Konformitetsdeklaration. Vi förklarar på eget ansvar att denna produkt överensstämmer med följande normer eller normativa dokument: EN 62841-1, EN ISO 12100, EN ISO 13857, EN 349, EN 28662-1, EN 61000-6-3, EN 61000-6-2, EN 1037 enligt bestämmelserna i direktiverna 2006/42/EG, 2014/30/EU, 2011/65/EU

**(DK)** CE-17 - Konformitetserklæring. Vi erklærer under almindeligt ansvar at dette produkt er i overensstemmelse med følgende normer eller normative dokumenter: EN 62841-1, EN ISO 12100, EN ISO 13857, EN 349, EN 28662-1, EN 61000-6-3, EN 61000-6-2, EN 1037 i henhold til bestemmelserne i direktiverne 2006/42/EØF, 2014/30/EU, 2011/65/EU

**(N)** CE-17 - Konformitetserklæring. Vi erklærer på eget ansvarighet at dette produkt er i overensstemmelse med følgende standarder eller standard-dokumenter: EN 62841-1, EN ISO 12100, EN ISO 13857, EN 349, EN 28662-1, EN 61000-6-3, EN 61000-6-2, EN 1037 i henhold til bestemmelserne i direktive ne 2006/42/EØF, 2014/30/EU, 2011/65/EU

**(FIN)** CE-17 - Todistus standardinmukaissuudesta. Asiaasta vastaavana todistamme täten, että tämä tuote on seuraavien standardien ja standardoimisasiakirjojen vaatimusten mukainen: EN 62841-1, EN ISO 12100, EN ISO 13857, EN 349, EN 28662-1, EN 61000-6-3, EN 61000-6-2, EN 1037 ja vastaa säädöksiä 2006/42/EG, 2014/30/EU, 2011/65/EU

**(SK)** CE-17 - Prehlásenie o zhode. Prehlasujeme na vlastnú zodpovednosť, že tieto produkty sú v súlade s nasledovnými normami: EN 62841-1, EN ISO 12100, EN ISO 13857, EN 349, EN 28662-1, EN 61000-6-3, EN 61000-6-2, EN 1037 a v zhode so smernicami 2006/42/EG, 2014/30/EU, 2011/65/EU

**(PL)** CE-17 - Zgodność z dyrektywami CE. Świadomi odpowiedzialności oświadczamy, że niniejszy produkt jest zgodny z następującymi normami lub dokumentacją normatywną: EN 62841-1, EN ISO 12100, EN ISO 13857, EN 349, EN 28662-1, EN 61000-6-3, EN 61000-6-2, EN 1037 zgodnie z postanowieniami wytycznych 2006/42/EG, 2014/30/EU, 2011/65/EU

**(CZ)** CE-17 - Prohlášení o shode. Prohlášíme na vlastní zodpovednosť, že tyto produkty splňují následující normy nebo normativní listiny: EN 62841-1, EN ISO 12100, EN ISO 13857, EN 349, EN 28662-1, EN 61000-6-3, EN 61000-6-2, EN 1037; Ve shode se smernicami 2006/42/EG, 2014/30/EU, 2011/65/EU

**(SLO)** CE-17 - Izjava o skladnosti. S tem potrjujemo splošno odgovornost, da je ta izdelek narejen v skladu z navedenimi normami in standardi: EN 62841-1, EN ISO 12100, EN ISO 13857, EN 349, EN 28662-1, EN 61000-6-3, EN 61000-6-2, EN 1037 ter določbami in smernicami 2006/42/EG, 2014/30/EU, 2011/65/EU

**(HR)** CE-17 - Izjava o skladnosti. Pod punom odgovornošću izjavljujemo da je proizvod naveden u naslovu ovog dokumenta sukladan sa primijenjenim normama i normativnim dokumentima: EN 62841-1, EN ISO 12100, EN ISO 13857, EN 349, EN 28662-1, EN 61000-6-3, EN 61000-6-2, EN 1037 u skladu sa odredbama preporuka 2006/42/EG, 2014/30/EU, 2011/65/EU

**(H)** CE-17 - Megfelelősségi nyilatkozat. Kéziműkötetésű elektromos kéziszerszámok: Teljes felelősséggel kijelentjük, hogy ezek a termékek a következő szabványokkal és irányelvekkel összhangban vannak: EN 62841-1, EN ISO 12100, EN ISO 13857, EN 349, EN 28662-1, EN 61000-6-3, EN 61000-6-2, EN 1037; és megfelelenek a rendeltetés szerinti 2006/42/EG, 2014/30/EU, 2011/65/EU irányelveknek.

**(RO)** CE-17 - Declarație de conformitate. Noi declarăm pe propria răspundere că acest produs este în conformitate cu următoarele norme și documente normative: EN 62841-1, EN ISO 12100, EN ISO 13857, EN 349, EN 28662-1, EN 61000-6-3, EN 61000-6-2, EN 1037; potrivit dispozițiilor directivelor 2006/42/EG, 2014/30/EU, 2011/65/EU

Remscheid, den 02.11.2017



Joh. - Christoph Schütz

Dipl.-Ing. Joh.-Christoph Schütz, CE-Beauftragter

**EMERSON PROFESSIONAL TOOLS**

地址: 上海松江工业区江田东路 89 号

电话: 400-820-5695

www.klauke.com.cn

# Handgeführtes batteriebetriebenes Elektrowerkzeug Typ ESG 25CFM

**Klauke**

(D) CE-17 - Konformitätserklärung **RED**. Wir erklären in alleiniger Verantwortlichkeit, daß dieses Produkt mit den folgenden Normen oder normativen Dokumenten übereinstimmt: EN 60950-1, EN 301489-1, EN 301489-17, EN 300328 V2.1.1, EN 62479 gemäß den Bestimmungen der Richtlinien 2014/53/EU, 2011/65/EU

(GB) CE-17 - 合格声明**RED**: 我们声明独自承担责任: 本产品符合以下标准或规范性文件:

EN 60950-1、EN 301489-1、EN 301489-17、EN 300328 V2.1.1、EN 62479符合2014/53/EU、2011/65/EU的规章制度。

(F) CE-17 - Déclaration de conformité **RED**. Nous déclarons sous notre seule responsabilité que ce produit est en conformité avec les normes ou documents normatifs suivants: EN 60950-1, EN 301489-1, EN 301489-17, EN 300328 V2.1.1, EN 62479 conformément aux réglementations des directives 2014/53/EU, 2011/65/EU

(E) CE-17 - Declaración de conformidad **RED**. Declaramos bajo nuestra sola responsabilidad que este producto está en conformidad con las normas o documentos normativos siguientes: EN 60950-1, EN 301489-1, EN 301489-17, EN 300328 V2.1.1, EN 62479 de acuerdo con las regulaciones de las directivas 2014/53/EU, 2011/65/EU

(I) CE-17 - Dichiarazione di conformità **RED**. Dichiariamo sotto la nostra esclusiva responsabilità che questo prodotto è conforme alle seguenti norme e documenti normativi: EN 60950-1, EN 301489-1, EN 301489-17, EN 300328 V2.1.1, EN 62479 conformemente alle disposizioni delle direttive 2014/53/EU, 2011/65/EU

(P) CE-17 - Declaração de conformidade **RED**. Declaramos sob nossa exclusiva responsabilidade que este produto cumpre as seguintes normas ou documentos normativos: EN 60950-1, EN 301489-1, EN 301489-17, EN 300328 V2.1.1, EN 62479 conforme as disposições das directivas 2014/53/EU, 2011/65/EU

(NL) CE-17 - Konformiteitsverklaring **RED**. Wij verklaren en wij stellen ons er alleen voor verantwoordelijk dat dit produkt voldoet aan de volgende normen of normatieve documenten: EN 60950-1, EN 301489-1, EN 301489-17, EN 300328 V2.1.1, EN 62479 overeenkomstig de bepalingen van de richtlijnen 2014/53/EU, 2011/65/EU

(GR) CE-17 - Μ ΣΗΣΩΦΡΟΜΜΥΣ ΗΣΩΛΗΑ**RED**. νοπορ οτ ιτο εμονοληδ σηκλονου ησηλανα ε προου συμφωνει με τα παρακατω ποοτυνα και με τα ηροτυνα ηου αναφερονται στα σχετικο εγγραφα ε EN 60950-1, EN 301489-1, EN 301489-17, EN 300328 V2.1.1, EN 62479 σύμφωνα με τοx κοινουτομοιο 2014/53/EU, 2011/65/EU

(S) CE-17 - Konformitetsdeklaration **RED**. Vi förklarar på eget ansvar att denna produkt överensstämmer med följande normer eller normativa dokument: EN 60950-1, EN 301489-1, EN 301489-17, EN 300328 V2.1.1, EN 62479 enligt bestämmelserna i direktiverna 2014/53/EU, 2011/65/EU

(DK) CE-17 - Konformitetserklæring **RED**. Vi erklærer under almindeligt ansvar at dette produkt er i overensstemmelse med følgende normer eller normative dokumenter: EN 60950-1, EN 301489-1, EN 301489-17, EN 300328 V2.1.1, EN 62479 i henhold til bestemmelserne i direktiverne 2014/53/EU, 2011/65/EU

(N) CE-17 - Konformitetserklæring **RED**. Vi erklærer på eget ansvarlighet at dette produkt er i overensstemmelse med følgende standarder eller standard-dokumenter: EN 60950-1, EN 301489-1, EN 301489-17, EN 300328 V2.1.1, EN 62479 i henhold til bestemmelsene i direktive ne 2014/53/EU, 2011/65/EU

(FIN) CE-17 - Todistus slandardinmukaisuudesta **RED**. Asiasta vastaavana todistamme läten, että tämä tuote on seuraavien standardien ja standardoimisasiakirjojen vaatimusten mukainen: EN 60950-1, EN 301489-1, EN 301489-17, EN 300328 V2.1.1, EN 62479 ja vastaa säädöksiä 2014/53/EU, 2011/65/EU

(SK) CE-17 - Prehlásenie o zhode **RED**. Prehlasujeme na vlastnú zodpovednosť, že tieto produkty sú v súlade s nasledovnými normami: EN 60950-1, EN 301489-1, EN 301489-17, EN 300328 V2.1.1, EN 62479 a v zhode so smernicami 2014/53/EU, 2011/65/EU

(PL) CE-17 - Zgodnosc z dyrektywami **RED**. Swiadomi odpowiedzialnosci oswiadczamy, ze niniejszy produkt jest zgodny z nastepujacymi normami lub dokumentacja normatywna: EN 60950-1, EN 301489-1, EN 301489-17, EN 300328 V2.1.1, EN 62479 zgodnie z postanowieniami wytycznych 2014/53/EU, 2011/65/EU

(CZ) CE-17 - Prohlášení o shode **RED**. Prohlasujeme na vlastní zodpovednosť, že tyto produkty splňují následující normy nebo normativní listiny: EN 60950-1, EN 301489-1, EN 301489-17, EN 300328 V2.1.1, EN 62479 Ve shode se smernicami 2014/53/EU, 2011/65/EU

(SLO) CE-17 - Izjava o skladnosti **RED**. S tem potrjujemo splošno odgovornost, da je ta izdelek narejen v skladu z navedenimi normami in standardi EN 60950-1, EN 301489-1, EN 301489-17, EN 300328 V2.1.1, EN 62479 ter določbami in smernicami 2014/53/EU, 2011/65/EU

(HR) CE-17 - Izjava o skladnosti **RED**. Pod punom odgovornošću izjavljujemo da je proizvod naveden u naslovu ovog dokumenta skladan sa primijenjenim normama i normativnim dokumentima : EN 60950-1, EN 301489-1, EN 301489-17, EN 300328 V2.1.1, EN 62479 u skladu sa odredbama preporuka 2014/53/EU, 2011/65/EU

(H) CE-17 - Megfelelősségi nyilatkozat **RED**. Kéziműködtetésű elektromos kéziszerszámok. Teljes felelősséggel kijelentjük, hogy ezek a termékek a következő szabványokkal és irányelvekkel összhangban vannak: EN 60950-1, EN 301489-1, EN 301489-17, EN 300328 V2.1.1, EN 62479 és megfelelnek a rendeltetés 2014/53/EU, 2011/65/EU irányelveknek.

(RO) CE-17 - Declarație de conformitate **RED**. Noi declarăm pe propria răspundere că acest produs este în conformitate cu următoarele norme și documente normative: EN 60950-1, EN 301489-1, EN 301489-17, EN 300328 V2.1.1, EN 62479 potrivit dispozițiilor directivei 2014/53/EU, 2011/65/EU

Remscheid, den 01.11.2017

**CE**   
Dipl.-Ing. Joh.-Christoph Schütz, CE-Beauftragter

**EMERSON PROFESSIONAL TOOLS**

地址: 上海松江工业区江田东路 89 号 电话: 400-820-5695 www.klauke.com.cn